



ENGLISH

GUNTAMATIC BIOMASS
BOILER HEATING RANGE

GUNTAMATIC

GUNTAMATIC HEATING GMBH

WE ARE ONE OF THE LEADING EUROPEAN MANUFACTURERS OF INNOVATIVE AND HIGH-EFFICIENCY BIOMASS BOILER HEATING SYSTEMS. OUR PRODUCTS ARE DISTINGUISHED BY EXCEPTIONAL RELIABILITY AND EASE OF USE.

WELL ESTABLISHED

With more than 120 sales and service agents in 17 countries, we are well established across Europe. We have built a reputation for high-quality products – from development through to production and from sales through to service.

HEATING WITH PASSION

We are engineers and boilermakers of conviction. With our requirements-based heating solutions, we aim to give our clients and trading partners the confidence of having chosen the right heating system.

HOLISTIC THINKING

As a systems provider we develop and produce highly durable and efficient boilers. The highly economical BIOSTAR range of pellet boilers is a perfect example.

GUNTAMATIC HEATING GMBH

| | |
|---------------------------|-----------------|
| Established: | 1963 |
| Company structure: | Family-owned |
| Sales and service agents: | 120 |
| Sales agents: | In 17 countries |
| Equity ratio: | 100 % |



We think and act according to our values. Decency, honesty and dependability are important to us because we always aim to give our customers more than we promise.



*Günther Huemer,
Managing Director of GUNTAMATIC Heating GmbH*



OUR AIM IS
TO DO
WHAT WE ARE
BEST AT –

MAKING
INNOVATIVE,
SAFE AND
RELIABLE
PRODUCTS.



To us, teamwork means transparency, acting in partnership and finding the best solution for your project.



Our production facilities are highly automated and our staff highly qualified. That is how we ensure the high quality and outstanding value for money of our heating systems.



The better the product, the lower the operating costs. This is why we pay attention to every detail in production.

CONTENTS

| | |
|---------------------------------|----|
| Biostar | 4 |
| Biocom and Powercorn | 6 |
| Powerchip | 8 |
| BMK | 10 |
| PRO | 12 |
| Technical Information Biostar | 14 |
| Technical Information Biocom | 16 |
| Technical Information Powerchip | 18 |
| Technical Information PRO | 20 |
| Technical Information BMK | 22 |
| Guarantees and service levels | 23 |

DISCOVER THE BIOSTAR FAMILY

OUR BIOSTAR SYSTEMS ARE THE FIRST SERIES-PRODUCED, LOW-TEMPERATURE WOOD PELLET BOILERS AND FEATURE LEADING TECHNOLOGIES BASED ON MANY YEARS OF RESEARCH AND DEVELOPMENT. THE LATEST GENERATION OF BOILERS HAVE TOUCH-SCREEN CONTROL PANELS, OUR HIGHEST EVER HEATING EFFICIENCIES AND AN UNRIVALLED STANDARD OF USABILITY.



THE BIOSTAR PELLET BOILERS

BIOSTAR 12 / 15 / 23 kW
(BIOSTAR W)





FIRST CLASS TECHNOLOGY

- Modulating bio combustion control from 3 - 23 kW
- Fully automated from fuel delivery, to ash removal and air supply to boiler cleaning
- Patented, low-temperature, non-condensing design
- Components with 200% safety factor
- Safe and simple operation using touch screen control panel
- Lambda probe oxygen monitoring for perfect combustion
- Can be fitted without thermal store



NO BUFFER NEEDED

The BIOSTAR can easily lower the temperature down to 38° C without loss of efficiency. In this way it requires no additional buffer tank. This not only saves time and space, but means that existing boilers can be replaced with major modifications.

RESEARCH AND DEVELOPMENT

After many years of research and development, the BIOSTAR is one of the most well proven low-temperature pellet boilers in Europe. Thanks to its touch-screen control panel and innovative technology, it is also one of the most advanced appliances on the market.



HIGHLY ADAPTABLE

The BIOSTAR FLEX model's high quality vacuum fuel delivery system offers maximum scope for fuel store placement up to 25m away from the boiler. A specially developed vacuum fed fuel hopper provides optimum dust separation and minimal maintenance. The hard-wearing rotary valve guarantees 100% burn-back protection in conjunction with the gravity feed system. High-quality, low energy drive motors ensure low electricity usage.

The "Flex" fuel feed auger provides for complete emptying of the fuel store and precise delivery to the vacuum feed system. With the BOX version, a large steel webbing hopper with feed auger removes the need for a purpose-designed storeroom.



INTELLIGENT, USER FRIENDLY TOUCH SCREEN CONTROL PANEL

Control is by way of a touch-screen control panel with a straightforward and clearly organised menu structure. All relevant settings, component tests and fault messages are easily accessible. The settings can also be controlled via smartphone with an optional GSM module.

EXPERIENCE THE BIOCOM AND POWERCORN SYSTEMS

THE BIOCOM RANGE IS AS USER-FRIENDLY AS IT IS ENERGY-EFFICIENT AND OFFERS HEAT OUTPUTS RANGING FROM 30 TO 400 KW. FEATURING MOVING, SELF CLEANING STEP GRATE TECHNOLOGY, THEY ENABLE CLINKERLESS COMBUSTION OF WOOD PELLETS OF VARYING QUALITIES AND CAN ALSO BURN GRAIN, WHEN FITTED WITH A STAINLESS STEEL LINER.



**BIOCOM 30, 40, 50
AND POWERCORN 30, 50**
Two sizes



**BIOCOM 75, 100
AND POWERCORN 75**
One size



BIOCOM CASCADE CONFIGURATION
Up to four systems, 400 kW maximum output





PERFECT COMBUSTION

The sophisticated control software ensures that the hot air fan ignites the fuel quickly and efficiently. Grain or wood pellets are burned at the ideal degassing temperature of approx. 650°C so that the formation of clinker is avoided. A moving, self cleaning step grate provides for the right amount of movement in the bed of glowing fuel and the easy removal of ash. The combustion gases produced are cleanly converted into energy in a generously dimensioned secondary combustion zone using secondary air.



TURBULATORS AND HEAT EXCHANGER CLEANING

Dust is separated into a specially developed heat exchanger tube. Corrosive materials condense on the double-walled surface and this protects and cleans the heat exchanger, which uses every degree of heat.



SIMPLE AND HIGHLY EFFICIENT

The lambda probe and temperature sensors ensure perfect combustion. The touch screen control panel gives the user performance information, such as combustion efficiency and boiler output. An optional outside temperature based control provides for optimum heat distribution and creates a comfortable working or living space.



SELF CLEANING FOR ULTIMATE CONVENIENCE

A slowly rotating ash auger carries the grate ash into a large 60-litre ash bin for easy removal. The dust from the heat exchanger cleaning mechanism is automatically removed into an easy to empty 12-litre ash box.

EXPERIENCE THE POWERCHIP BOILER RANGE

THE USER-FRIENDLY AND ULTRA-EFFICIENT POWERCHIP RANGE OFFERS UNIQUE FUEL FLEXIBILITY. THESE BOILERS WILL BURN WOOD CHIPS, WOOD PELLETS, GRAIN OR MISCANTHUS AND FUEL TYPE CAN BE CHANGED AT THE TOUCH OF A BUTTON. THEY ARE ESPECIALLY SUITABLE FOR FACTORIES, SCHOOLS, AGRICULTURAL FACILITIES AND DISTRICT HEATING SCHEMES. WITH TOUCH-SCREEN CONTROL PANELS THEY ARE ALSO VERY EASY TO OPERATE.



POWERCHIP 20/30, 40/50, POWERCORN 50 SPECIAL

Three sizes



POWERCHIP 75, 100

One size, range of outputs in modulation



POWERCHIP CASCADE CONFIGURATION

Link up to four boiler systems, 400 kW maximum output.





PERFECT COMBUSTION

Sophisticated electronic controls ensure that the hot air fan ignites the fuel quickly and efficiently. Wood chips, wood pellets, miscanthus or grain are efficiently burned at the ideal temperature of 650°C. A self-cleaning, moving step grate provides for the right amount of movement in the bed of glowing fuel and the easy removal of ash. The hot combustion gases are re-burned at temperatures up to 1,200°C and cleanly converted into energy in a generously proportioned secondary combustion chamber.



TURBULATORS AND HEAT EXCHANGER

The combustion gases are cleanly converted into hot water in a specially developed heat exchanger and dust removed by an efficient vacuum separator. The adjoining jacket-and-tube heat exchanger constantly cleans itself using moving turbulators and converts every degree of heat produced.

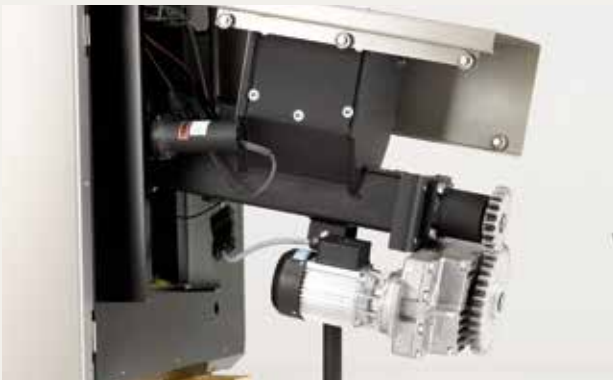

THE FEED AUGER

Wood chips, wood pellets, miscanthus or grain are conveyed by the fuel store feed auger, which is monitored by a burnback-inhibiting chute with safety cover into the feed auger. A sophisticated lambda control constantly optimises the fuel feed rate. Additional operational reliability is provided by the fill-level indicator in the boiler.

THE FUEL DELIVERY SYSTEM

The durable fuel feed auger with sprung-arm agitator conveys wood chips, wood pellets, miscanthus or grain with the minimum of force and without overloading the equipment. Durable gears and electric motors offer maximum operational reliability. The unique modular structure simplifies transportation and assembly of the system.



MAXIMUM SAFETY

The integral flue draught fan not only provides exactly the right amount of air but also creates a constant draw in the firebox. In conjunction with the burnback-inhibiting fuel chute and a tested fire safety flap, complete burn-back protection is provided for. The touch screen control panel offers fault diagnosis and the option of remote monitoring from your mobile phone ensures you are always in control.

BMK FUTURE-PROOF HEATING

THE NEW BMK IS THE IDEAL SOLUTION FOR ANYONE LOOKING FOR AN INNOVATIVE AND SOLID LOG BOILER. IT IS EXCEPTIONALLY USER-FRIENDLY, DURABLE AND SETS NEW STANDARDS IN TERMS OF EFFICIENCY AND RELIABILITY.



LOG GASIFIER BUILT FROM HIGH-QUALITY STAINLESS STEEL

Log boiler for 1/2-metre logs
20, 30, 40, 50 kW





EXCEPTIONAL PRACTICALITY AND EASE OF USE.

This appliance is high-quality, durable and features a firebox made from high grade stainless steel. The advanced, modulating design enables unrivalled combustion efficiency at temperatures of over 1400°C. This enables the boiler to burn a wide variety of fuel and fuel hopper capacities of 166 or 215 litres minimise the time between fills. Combined with an automatic ignition option, the BMK is one of the most modern and sophisticated log boilers on the market.



FIRST CLASS COMBUSTION

The technological heart of the BMK has proven itself a thousand times over. In the latest generation of boilers, this has been further optimised to offer unrivalled reliability. The burn chamber features exceptionally controllable combustion and means the appliance can easily cope with a wide variety of fuel quality.



THE POWER OF RESPONSIBILITY

The experience gained from manufacturing thousands of log boilers is combined with an inexhaustible desire for perfection.

- High-quality stainless steel fire box
- Fully insulated combustion zone
- Zone control of combustion air
- Variable heat exchanger output modulation
- Unique, automatic hot-air ignition
- Combustion optimised using lambda probe
- Easy to operate using touch-screen control panel
- Thermal store program with refuel prompt
- Long refuelling intervals
- Efficiency up to 94%

THE PRO INDUSTRIAL BIOMASS PLANT

THE PRO SERIES OFFERS UNRIVALLED LEVELS OF FUEL ECONOMY AND SAFETY FOR MEDIUM TO LARGE SCALE WOOD PELLET AND WOOD CHIP HEATING. THANKS TO THE MODULAR DESIGN, THESE MEDIUM TO LARGE SCALE SYSTEMS ARE VERY FLEXIBLE AND OFFER HEAT OUTPUTS OF UP TO 1000 KW.



The PRO series 175 / 250



The PRO series 600 / 750



The PRO series 350 / 425 / 500



The PRO series 850 / 1000





MAXIMUM SAFETY

This range features extremely high-quality components, backed up by 15 years of research, development and manufacturing experience. This guarantees maximum safety, low maintenance costs and long service life. For larger heat output requirements, several systems cascaded together offer high levels of reliability and efficiency in modulation. This offers great benefits for commercial and industrial users.



HIGH EFFICIENCY COMBUSTION

Fuel is gasified with controlled primary air and controlled combustion conditions. The amount of air and fuel required is regulated by lambda probe, which ensures maximum efficiency. Combustion gases are fed with secondary air in a large combustion zone and generate temperatures of 1,300 °C.



SELF CLEANING

Vertically arranged turbulators continually move up and down to keep the heat exchanger clean. This prevents the build up of efficiency-reducing deposits and ensures consistently low heat losses. Moreover, they make sure that the boiler can run for long periods with minimal maintenance or cleaning.



SERIES PRODUCTION ADVANTAGES / SPARE PARTS AVAILABILITY

PRO industrial boilers are standardized, series-produced heating systems. They use the highest quality components, which have been extensively tested. Spare parts are easily and quickly available and can be replaced by your heating engineer on site or by an authorised service technician.

HIGHEST LEVELS OF FIRE SAFETY

A sophisticated burn back protection system offers high levels of safety. A suction fan generates a constant negative pressure in the combustion chamber and an automatic rotary valve prevents burn back. Larger systems are also equipped with a temperature control in the fuel store.

BIOSTAR TECHNICAL DATA AND SPECIFICATIONS

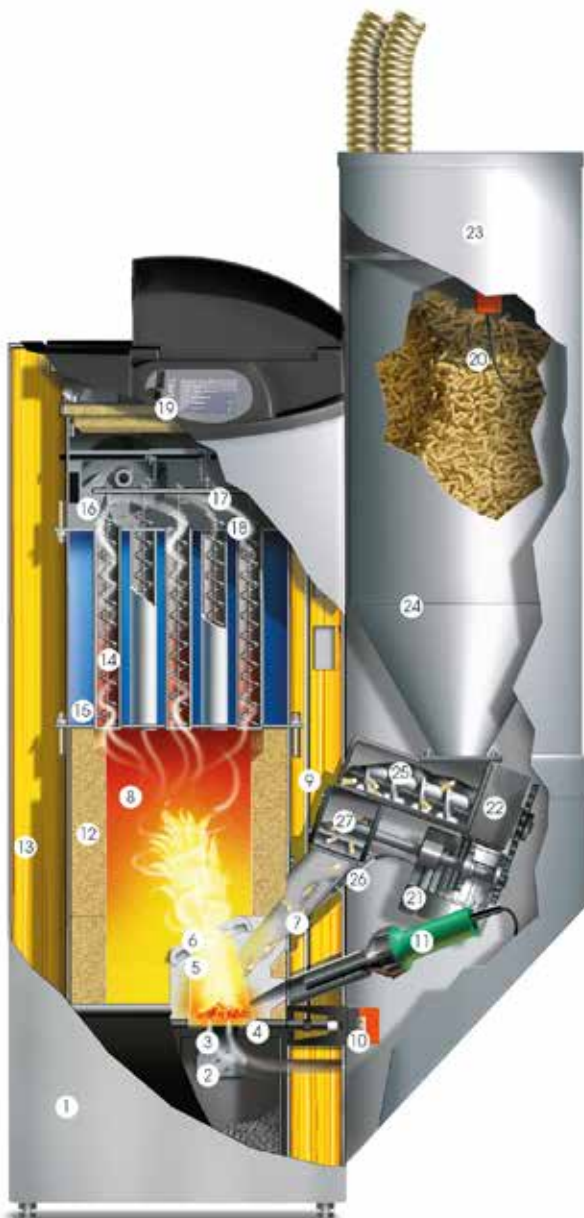

BIOSTAR FLEX-VACUUM FUEL OUTFEED

1. Door to ash bin
2. Grate cleaning plate
3. Primary Air
4. Self-cleaning grate
5. Secondary air
6. Spiral jet
7. Burn back proof drop shaft
8. Combustion zone
9. Automatic heat exchanger cleaning
10. Cleaning motor
11. Hot air ignition
12. Ceramic insulation
13. Full insulation
14. Turbulator
15. Tubular heat exchanger
16. Extraction draught fan
17. Flue gas sensor
18. Lambda probe
19. Touch screen control panel
20. Fill level sensor
21. Motor
22. Drive
23. Suction fan
24. Hopper tank
25. Conveyor auger for pellets
26. Monitoring sensor
27. Rotary sluice valve

MODULATING BIO COMBUSTION CONTROL

Perfect modulation at peak efficiency from 26-100%, enables the boiler to automatically adjust to suit heat demand. This avoids cold starts, lengthens the boiler's working life, drives high combustion efficiencies, and leads to reduced fuel consumption.

HEAT EXCHANGER

Tubular heat exchanger with variable output. The higher the speed of the combustion gases, the greater the heat exchanger efficiency. No condensation formation even at low temperatures due to the patented injection system.

VACUUM FUEL OUTFEED

- Optimised vacuum dust separation
- Rotary feeder positioning after feed auger means no pellets break, a permanent seal and permanent burn-back prevention.

FLEX-VACUUM FUEL DELIVERY SYSTEM

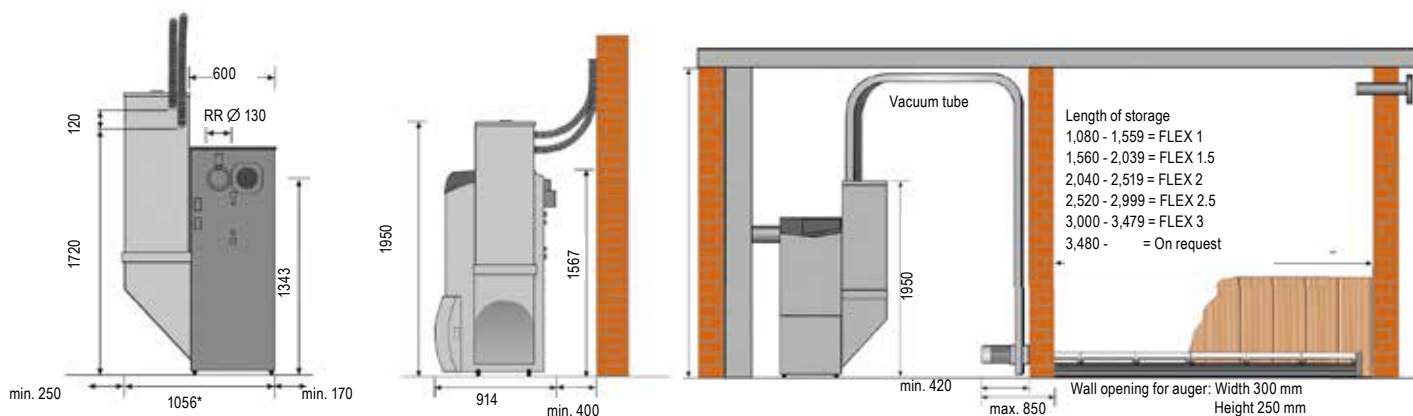

- Vacuum container: approx. 100 litres
- Vacuum pipe: max. 25 m (1st floor: max. 15m)
- Refill time: 8 - 10 min.
- Weight per metre of fuel-store auger: approx. 40 kg

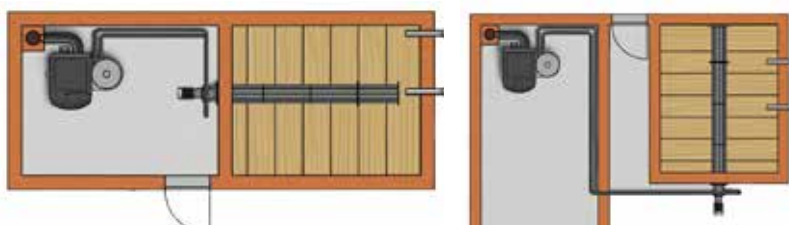

The vacuum system collects the pellets at the end of the outfeed auger and sucks them to the fuel hopper. The fuel store does not have to be directly adjacent to the boiler. The vacuum tube can span distances of up to 25 m.

BIOSTAR BOX VACUUM DELIVERY SYSTEM

| Box | 7.5 | 8.3 | 11 | 14 | |
|-----------------|---------|---------|----------|-----------|----------------|
| Width | 2.1 | 2.9 | 2.5 | 2.9 | m |
| Depth | 2.1 | 1.7 | 2.5 | 2.9 | m |
| Height | 1.8-2.5 | 1.9-2.5 | 1.8-2.5 | 1.9-2.5 | m |
| Hopper capacity | 5.0-7.5 | 6.1-8.3 | 8.3-11.0 | 10.2-14.1 | m ³ |

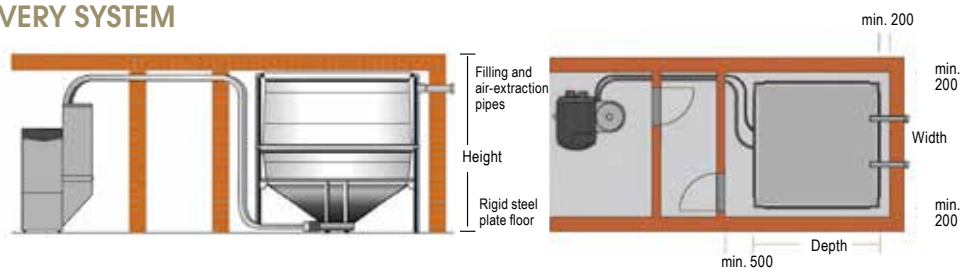

| Technical data | 12 | 15 | 23 | |
|-------------------------|-------------------|-------------------|-------------------|-------------------|
| Fuel | Pellets ENPlus A1 | Pellets ENPlus A1 | Pellets ENPlus A1 | EU-Norm EN14961-2 |
| Rated output | 12 | 15 | 23** | kW |
| Minimum output | 3.3 | 3.5 | 6.9 | kW |
| Required flue draught | 0,1 | 0,1 | 0,15 | mbar |
| Boiler temperature | 38 - 80 | 38 - 80 | 38 - 80 | °C |
| Boiler weight | 298 | 300 | 305 | kg |
| Minimum flow rate | 600 | 600 | 600 | l/h |
| Water system resistance | 11.7 | 17.2 | 37.7 | mbar |
| Heat exchanger cleaning | automatic | automatic | automatic | |
| Integrated ash box | 38 | 38 | 38 | litres |
| Boiler efficiency | 94.7 | 94.8 | 94.7 | % |

* BIOSTAR W: width = 1.620 mm

** BIOSTAR 23W output = 20 kW

BIOCOM / POWERCORN TECHNICAL DATA AND SPECIFICATIONS

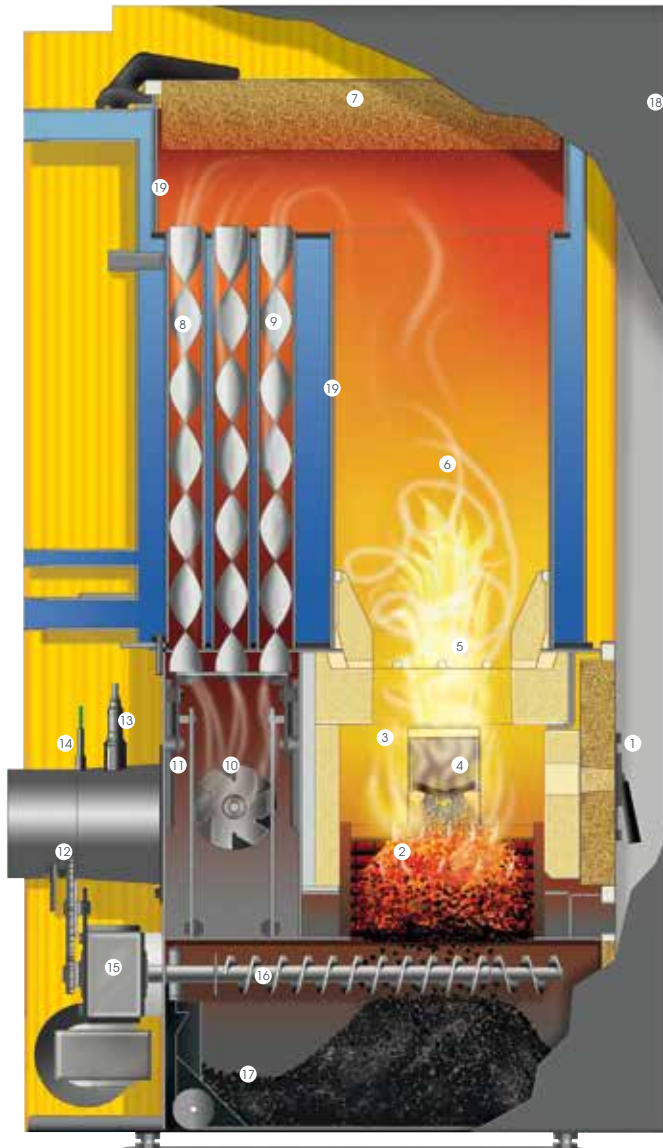

BIOCORN / POWERCORN

1. Firebox door
2. Step grate - primary air
3. Combustion chamber
4. Fill level indicator
5. Spiral jet - secondary air
6. Gas combustion zone
7. Boiler lid
8. Turbulators
9. Heat exchanger tubes
10. Combustion fan
11. Heat exchanger cleaning mechanism
12. Flue pipe connection
13. Lambda probe
14. Thermostat
15. Cleaning/ grate drive
16. Ash auger
17. Ash bin
18. Touch screen control panel
19. Stainless steel liner for grain

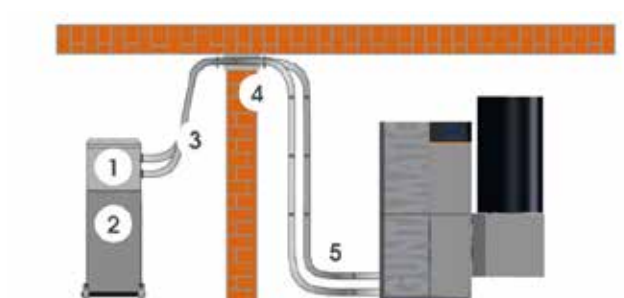

1. Ash removal vacuum
2. 200 Litre ash bin
3. Vacuum Tube
4. Rockwool fire proof liner
5. Fire protection ring

FLEX-VACUUM FUEL DELIVERY SYSTEM

BIOCOM/POWERCORN 30-50

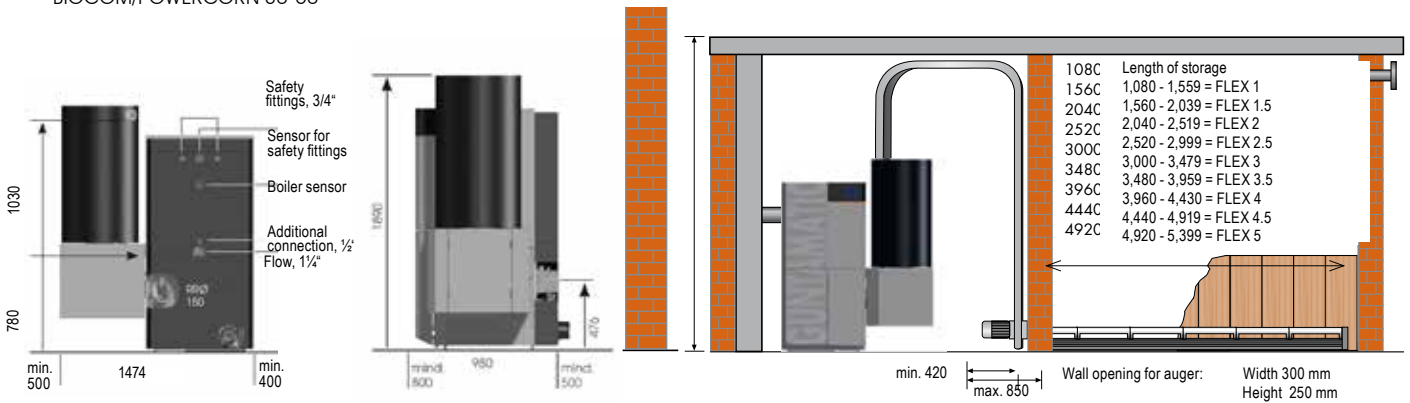

BIOCOM/POWERCORN 75-100

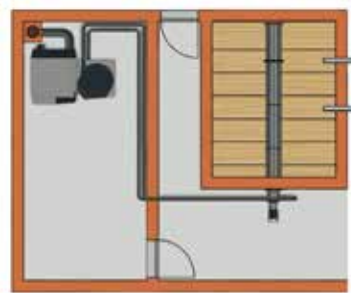
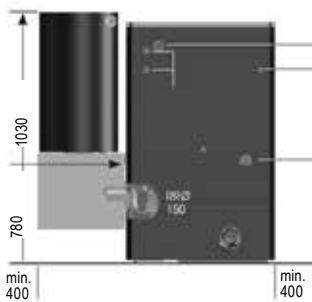

The vacuum system picks up the pellets at the end of the outfeed auger and conveys them to the fuel hopper.

- Vacuum container: approx. 200 litres
- Vacuum pipe: max. 25 m (1st floor: max. 15m)

The storeroom does not have to be directly adjacent to the boiler room. The vacuum tube can span distances of up to 25 m.

BOX VACUUM FUEL OUTFEED

| Box | 7.5 | 8.3 | 11 | 14 | |
|-----------------|---------|---------|----------|-----------|----------------|
| Width | 2.1 | 2.9 | 2.5 | 2.9 | m |
| Depth | 2.1 | 1.7 | 2.5 | 2.9 | m |
| Height | 1.8-2.5 | 1.9-2.5 | 1.8-2.5 | 1.9-2.5 | m |
| Hopper capacity | 5.0-7.5 | 6.1-8.3 | 8.3-11.0 | 10.2-14.1 | m ³ |

Pellets = 650 kg/m³
Grain = 750 kg/m³

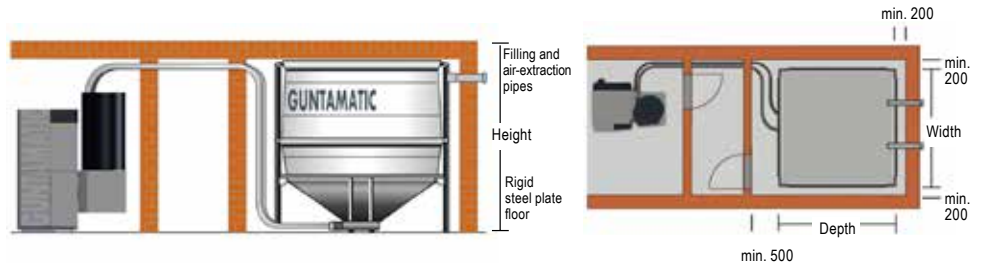

| Technical data | BIOCOM 30 POWERCORN 30 | BIOCOM 40 | BIOCOM 50 POWERCORN 50 | BIOCOM 75 POWERCORN 75 | BIOCOM 100 | |
|--|---|-----------|---------------------------|--|------------|-------------------|
| Fuel BIOCOM | Wood pellets ENPlus A1 and A2 | | | | | EU-Norm EN14961-2 |
| Fuel POWERCORN | Wood pellets ENPlus A1 and A2; Grain ONORM M7139*** (Miscanthus and agricultural pellets****) | | | | | |
| Boiler output: Wood pellets | 7-30 | 9-40 | 12-50 | 22-75 | 22-100 | kW |
| Boiler output: Grain (with slaked lime additive) | 7-25 | | 12-40 | 21-70 | | |
| Required flue draught | 0.15 | 0.15 | 0.15 | 0.15 | 0.15 | mbar |
| Boiler temperature Wood pellets | 50-80 | 50-80 | 50-80 | 60-80 | 60-80 | °C |
| Boiler temperature Grain | 70-80 | | 70-80 | 70-80 | | |
| Return temperature Wood pellets | >40 | >40 | >40 | >45 | >45 | °C |
| Return temperature Grain | >55 | | >55 | >55 | | |
| Return boost | Pump (RA60 with thermal store) | | | Pump (return boost with thermal store) | | |
| Water capacity | 128 | 128 | 147 | 256 | 256 | litres |
| Operating pressure (max.) | 3 | 3 | 3 | 3 | 3 | bar |
| Ash bin, "grate" | 60 | 60 | 60 | 80 | 80 | litres |
| Ash bin, "heat exchanger" | 12 | 12 | 12 | 12 | 12 | litres |
| Flue connection diameter | 150 | 150 | 150 | 180 | 180 | mm |
| Weight | 550 / 562** | 553 | 585 / 667** | 865 / 890** | 865 | kg |
| Weight of lower unit | 340 | 340 | 340 / 410** | 430 | 430 | kg |
| Weight of heat exchanger | 180 / 192** | 183 | 215 / 227** | 405 | 405 | kg |
| Weight of feed auger | 70 | 70 | 70 | 70 | 70 | kg |
| Weight of drive unit | 26 | 26 | 26 | 26 | 26 | kg |
| Weight including feed auger | 40 | 40 | 40 | 40 | 40 | kg |
| Safety heat exchanger | Yes | | | | | |
| Power supply | 230 V / 13 A | | | | | |

In cascade mode, up to four boilers can be connected

* Details for BIOCOM range

** Details for POWERCORN range

*** The boiler is capable of burning grain if permitted by local regulations and the specified emission limits are complied with.

**** The systems are fundamentally suitable for use with organic fuels; however there are no specific type approvals available. The possibility of such use should be verified in each particular case with reference to the relevant local regulations and emission limits.

POWERCHIP TECHNICAL DATA AND SPECIFICATIONS

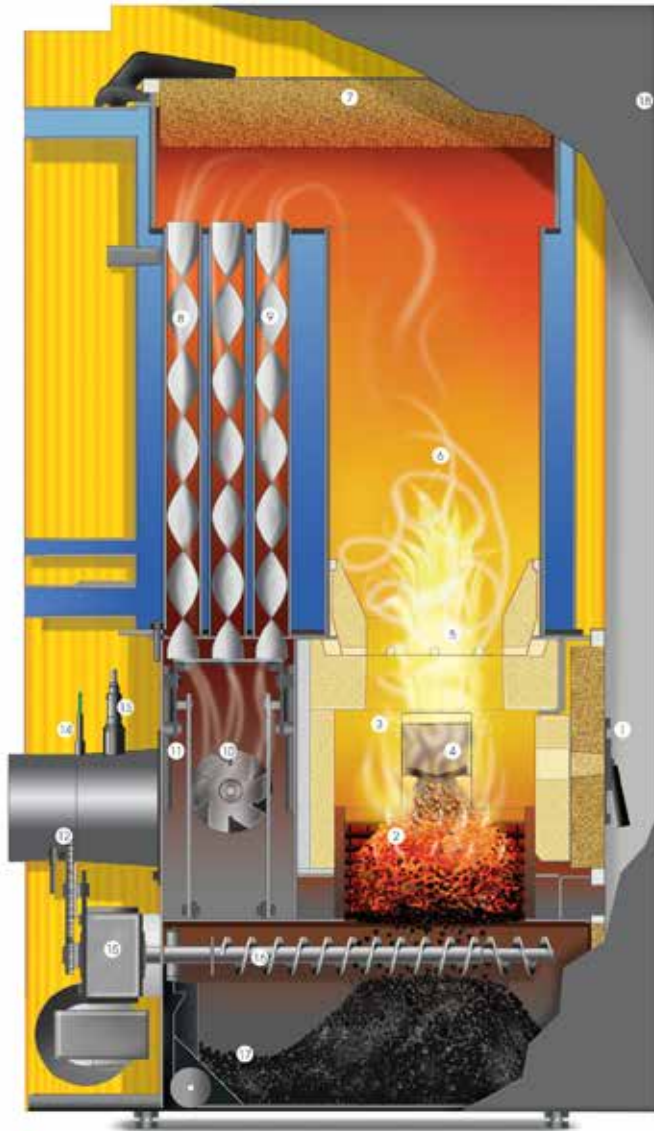

POWERCHIP

1. Firebox door
2. Step grate - primary air
3. Combustion chamber
4. Fill level indicator
5. Spiral jet - secondary air
6. Gas combustion zone
7. Boiler lid
8. Turbulators
9. Heat exchanger tubes
10. Combustion fan
11. Heat exchanger cleaning mechanism
12. Flue pipe connection
13. Lambda probe
14. Thermostat
15. Cleaning/ grate drive
16. Ash auger
17. Ash bin
18. Touch screen control panel
19. Burn back protection
20. Feed auger
21. Wall opening



1. Room safety thermostat
2. Fuel feed auger

POWERCHIP UP TO 50 KW

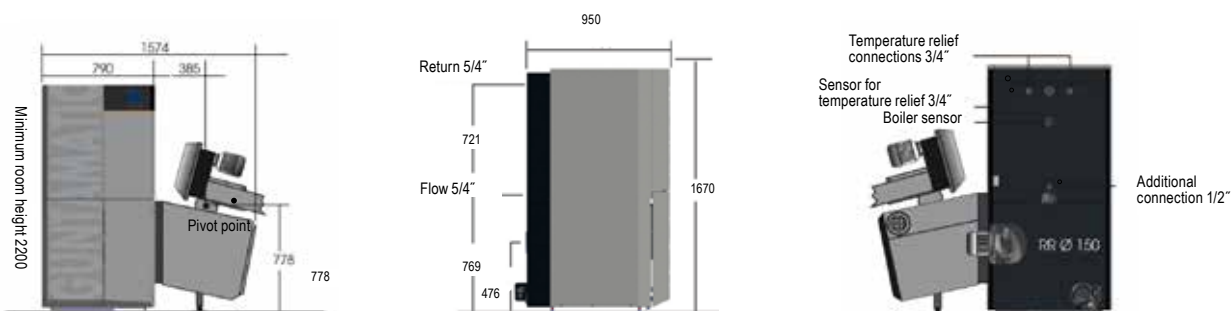

POWERCHIP 75 KW OR OVER

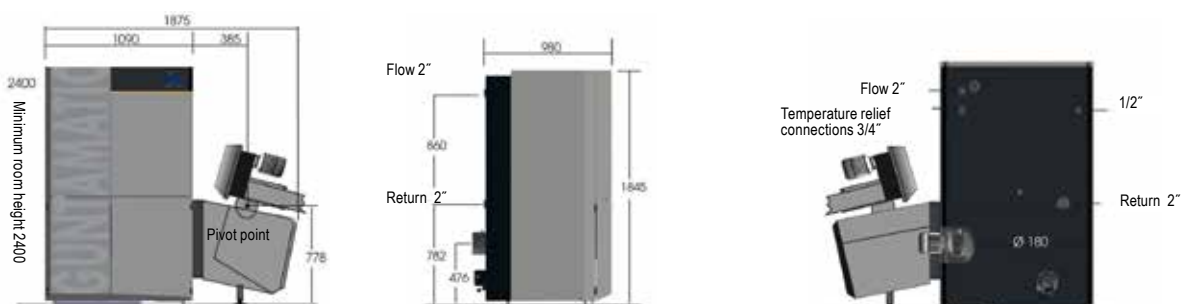

FUEL STORE FEED AUGER

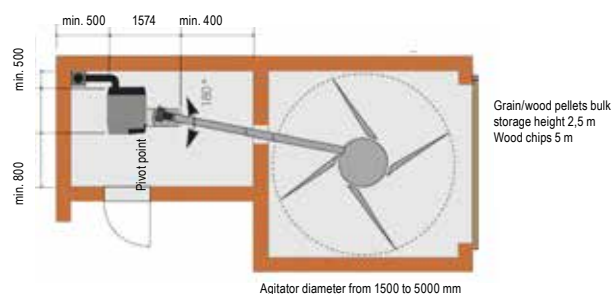
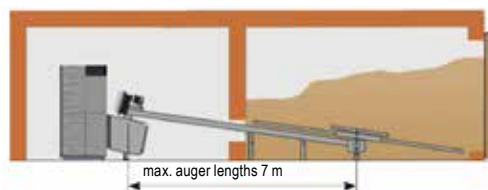

Grain/wood pellets bulk storage height 2.5 m
Wood chips 5 m

FUEL STORE OPTIONS



| Technical data | Powerchip 20/30 | Powerchip 40/50 | Powerchip 75 | Powerchip 100 | |
|-------------------------------------|--|---|---|---|---|
| Fuel | Wood chips G 30, G 50* Wood pellets ENPlus A1 and A2 Grain ** and Miscanthus *** | | | | ÖNORM M7133 EU-Norm EN14961-2 ÖNORM M7139 |
| Boiler output | Wood chips 7 - 30 Wood pellets 7 - 30 Grain 7 - 25 Miscanthus 7 - 25 | Wood chips 12 - 50 Wood pellets 12 - 50 Grain 12 - 25 Miscanthus 12 - 25 | Wood chips 22 - 75 Wood pellets 22 - 75 Grain 21 - 70 (with slaked lime additive) Miscanthus 21 - 70 (with slaked lime additive) | Wood chips 25.5 - 85 Wood pellets 22 - 75 Wood pellets 22 - 100 | kW kW kW kW |
| Required flue draught | 0.15 | 0.15 | 0.15 | 0.2 | mbar |
| Boiler temperature | 65 - 80 (70 Grain) | 65 - 80 (70 Grain) | 65 - 80 (70 Grain) | 65 - 80 (70 Grain) | °C |
| Return temperature | 55 | 55 | 55 | 55 | °C |
| Return boost | Pump (RA60 with thermal store) | | Pump (Return boost with thermal store) | | |
| Water capacity | 128 | 147 | 256 | 256 | litres |
| Operating pressure (max.) | 3 | 3 | 3 | 3 | bar |
| Ash bin, "grate" | 60 | 60 | 80 | 80 | litres |
| Ash bin, "heat exchanger" | 12 | 12 | 12 | 12 | litres |
| System width | 1574 | 1574 | 1875 | 1875 | mm |
| Flue pipe connection diameter | 150 | 150 | 180 | 180 | mm |
| Overall weight (without feed auger) | 550 | 585 | 865 | 865 | kg |
| Weight of lower unit | 340 | 340 | 430 | 430 | kg |
| Weight of heat exchanger | 180 | 215 | 405 | 405 | kg |
| Weight of feed auger | 75 | 75 | 75 | 75 | kg |
| Temperature-relief heat exchanger | Yes | | | | |
| Power supply | 400 V / 13 A | | | | |

In cascade mode up to four different boilers can be combined. * In order to ensure fault-free operation, the G50 standard criteria must be precisely complied with. Therefore, please make sure wood chipper blades are sharp or alternatively use G30 woodchips. ** additional equipment required.

*** additional lining required.

PRO INDUSTRIAL BIOMASS PLANT TECHNICAL DATA AND SPECIFICATIONS



PRO FEATURES AND BENEFITS

1. Step grate - primary air
2. Gasification chamber
3. Ember bed control
4. Cleaning cover
5. Turbulators
6. Heat exchanger
7. Combustion fan
8. Automatic cleaning device
9. Flue pipe connection
10. Lambda probe
11. Flue gas probe
12. Step grate drive
13. Ash bin
14. Touch screen control panel
15. LED power indicator

PRO FLEX PELLET FUEL DELIVERY SYSTEM



Length of storage

1,080 - 1,559 = FLEX 1

1,560 - 2,039 = FLEX 1.5

2,040 - 2,519 = FLEX 2



2,520 - 2,999 = FLEX 2.5

3,000 - 3,479 = FLEX 3

3,480 - 3,959 = FLEX 3.5

3,960 - 4,439 = FLEX 4

4,440 - 4,919 = FLEX 4.5

4,920 - 5,399 = FLEX 5

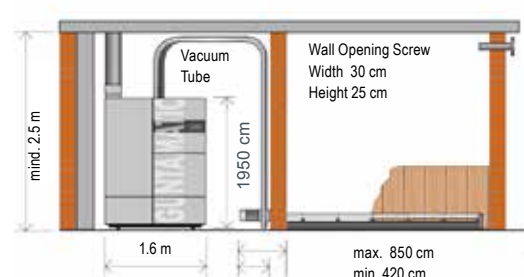

PRO WOOD CHIP FUEL DELIVERY SYSTEM

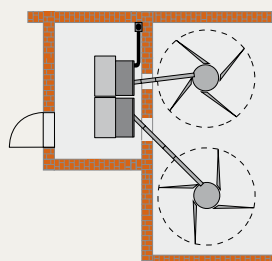

Agitator Diameter
1.5 to 5.0 m

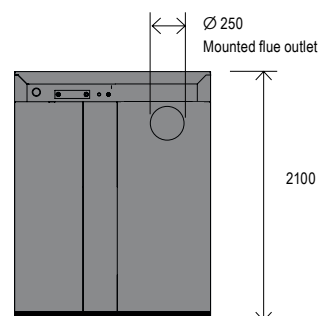
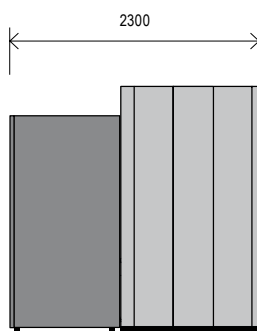
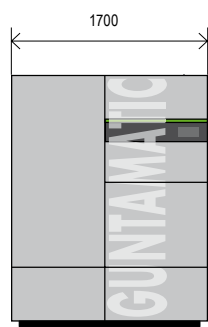
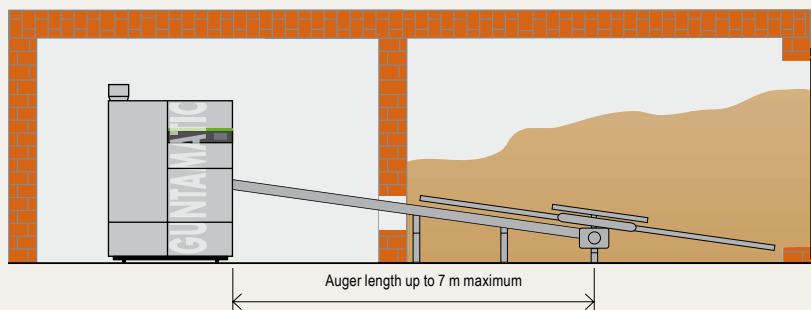

| Technical data | Type PRO 175 Type PRO 250 | Set PRO 350 Set PRO 425 Set PRO 500 | Set PRO 600 Set PRO 750 | Set PRO 850 Set PRO 1000 | |
|------------------------------|-------------------------------|---|----------------------------|-----------------------------|-------------------|
| Fuel PRO | Wood Chips G30 and G50 | | | | ÖNORM M7133 |
| Fuel PRO Flex | Wood Pellets ENplus A1 and A2 | | | | EU-Norm EN14961-2 |
| Boiler output PRO (Flex) 175 | 188 | Overall performance results from a combination of modules | | | kW |
| Boiler output PRO (Flex) 250 | 199,5* / 250** | | | | kW |
| Required chimney draft | 0,1 | 0,1 | 0,1 | 0,1 | mbar |
| Boiler temperature | 60 - 85 | 60 - 85 | 60 - 85 | 60 - 85 | °C |
| Return temperature | 55 | 55 | 55 | 55 | °C |
| Water content | 600 | 1.200 | 1.800 | 2.400 | litres |
| Operation pressure | max. 3 | max. 3 | max. 3 | max. 3 | bar |
| Ash content | max. 240 | max. 480 | max. 720 | max. 960 | litres |
| Flue pipe diameter (outside) | 250 | 2x 250 | 3x 250 | 4x 250 | mm |
| Total weight | approx. 2,000 | approx. 4,000 | approx. 6,000 | approx. 8,000 | kg |
| Safety heat exchanger | Yes | Yes | Yes | Yes | |
| Electrical usage | 400 V / 20 A | 400 V / 20 A | 400 V / 20 A | 400 V / 20 A | |

* Nominal power module for below 400 kW

** Maximum boiler output

BMK TECHNICAL DATA AND SPECIFICATIONS



BMK

1. Large primary combustion chamber
2. Cast iron grate
3. Ash bin
4. Preheated secondary air
5. Preheated primary air
6. Turbo secondary combustion area
7. Turbulators
8. Cleaning lever
9. Combustion fan
10. Flue pipe connection
11. Touch screen control panel
12. Low energy servo motors for primary and secondary air
13. Thick all round insulation
14. Secondary gas duct
15. Automatic Ignition Option

SECONDARY COMBUSTION ZONE:

Fully insulated gasification, ignition and secondary combustion zone. Easy removal of ash bin.

ZONE CONTROL OF COMBUSTION AIR:

The right amount of oxygen in the right place for all secondary combustion

HEAT EXCHANGER:

Tubular heat exchanger with variable output; cleaned from outside.

| Technical data | | BMK 20/30 | BMK 40/50 | |
|--|-----------|-------------|-------------|--------|
| Heating output | | 20/30 | 40/50 | kW |
| Boiler dimensions with insulation | Width, D | 973 | 973 | mm |
| | Height, E | 1440 | 1640 | mm |
| | Depth, F | 940 | 940 | mm |
| Fuel capacity | | 166 | 215 | litres |
| Fuel box width | | 370 | 370 | mm |
| Fire box depth | | 580 | 580 | mm |
| Water capacity | | 125 | 175 | Liter |
| Max. operating pressure | | 3 | 3 | bar |
| Carriage weight approx. | | 630 | 730 | kg |
| Flow and return | | R 1 1/4 | R 1 1/4 | Zoll |
| Flow height / Return height | | 1047 / 568 | 1247 / 568 | mm |
| Height of flue connection, C (without elbow) | | 1334 | 1534 | mm |
| Flue connection diameter (external) | | 150 | 150 | mm |
| Required flue draught | | 0.12 | 0.12 | mbar |
| Boiler dimensions (no insulation) | Width | 965 | 965 | mm |
| | Height | 1310 | 1510 | mm |
| | Depth | 795 | 795 | mm |
| Power supply | | 230V / 13 A | 230V / 13 A | |

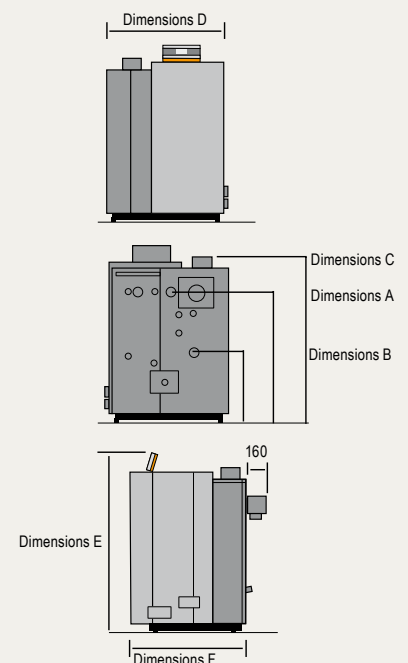



GUARANTEES AND SERVICE LEVELS

As a market leader, we pay special attention to the build quality of each and every boiler. If you should encounter any problems we will make sure you are offered a suitable solution as quickly as is possible.

Because of our approved network of service agents we can offer the highest levels of customer service available.



Our recipe for success is straightforward and practical – we don't sell anything we are not confident about. We don't make any promises we can't keep.



*Kurt Kaufmann,
Service Manager since 1984*





PRO / Industrial system

GUNTAMATIC HEATING SOLUTIONS



BIOSTAR
Low-temperature pellet boiler



POWERCHIP / Woodchip boiler



POWERCHIP / Woodchip boiler



BMK
Log boiler



POWERCORN / Grain fuel boiler



BIOCOM / Industrial pellet boiler

GUNTAMATIC HEATING GMBH

Bruck 7 . 4722 Peuerbach . Austria
Tel. 0043(0)7276-2441-0 . Fax 0043(0)7276-3031 . office@guntamatic.com . www.guntamatic.com

06/2013 . Subject to printing errors and technical amendments.